

TOTEM

via pier lombardo, 6  
20135 - milano  
info@totem.ws  
www.totem.ws

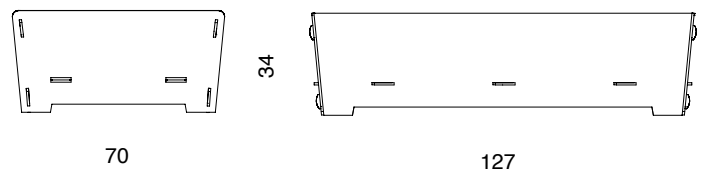
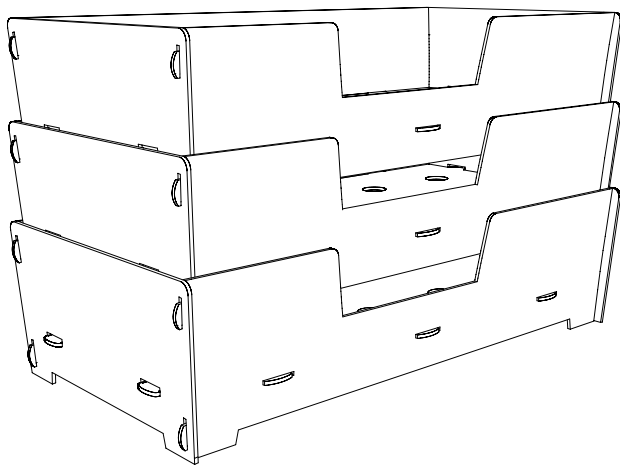
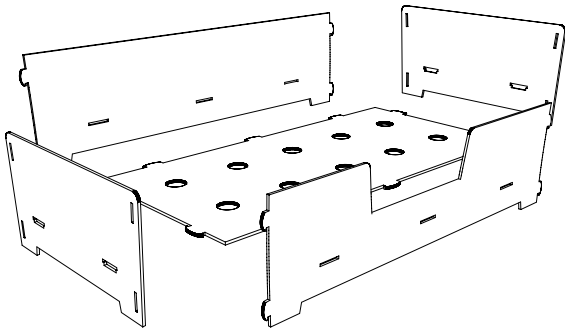

## child's bed L1

Child's bed in laser cut birch plywood. One of the sides has an opening so the child can climb in and out of the bed unassisted. These beds can be stacked when not in use.

The five components that make up the bed are assembled by joints.

The surfaces can be colored or finished with natural oil.

elements

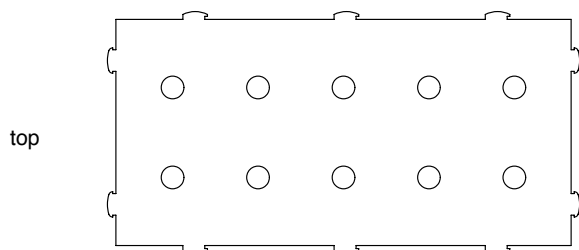

top

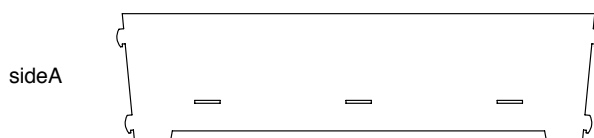

sideA

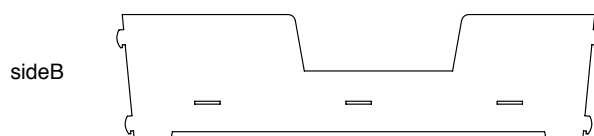

sideB

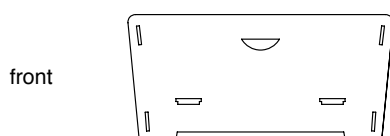

front

